

Pagoda

008.001.006.001

DS008.001.006-v02 (2017-06)



© 2017

Blue Rabbit 2.0 - Hemelrijken 8 - B-2890 St-Amands - Belgium.
Copyrighted material - Do not reproduce under penalty of law.

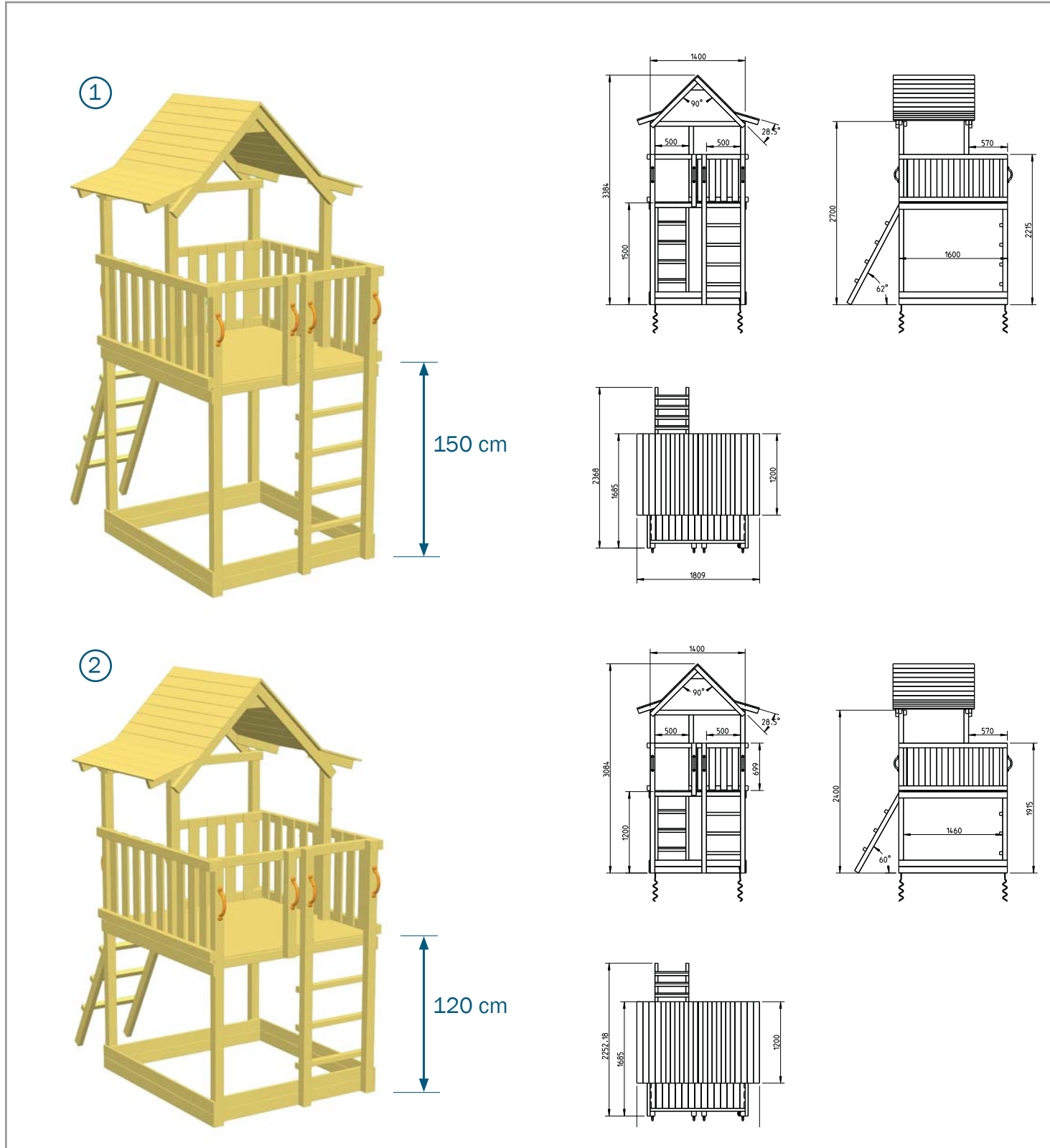

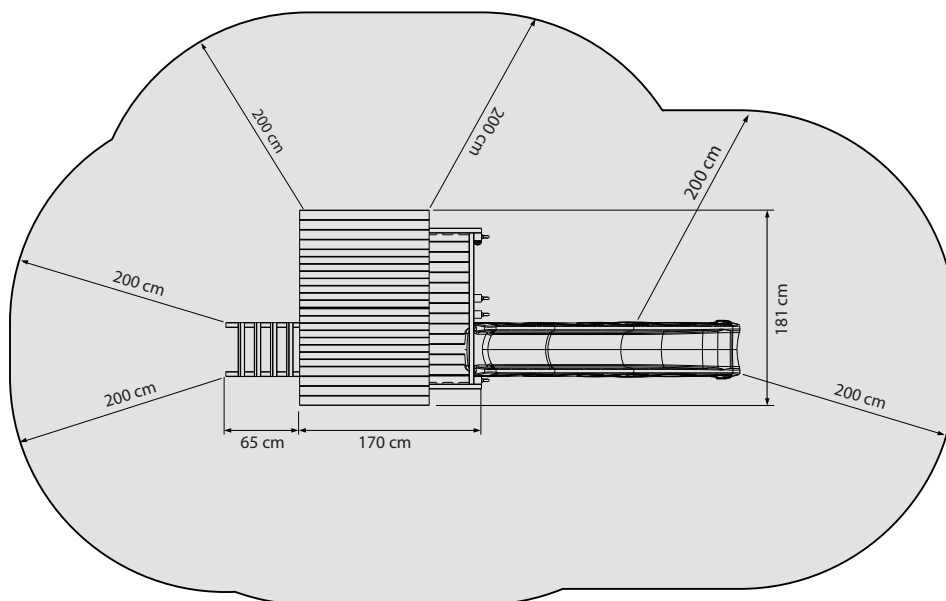
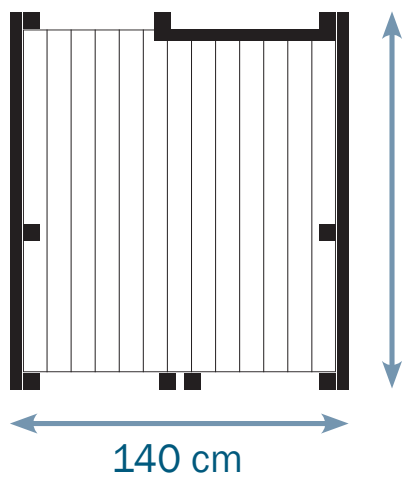



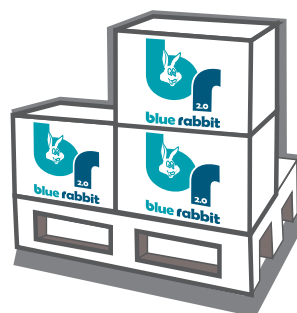
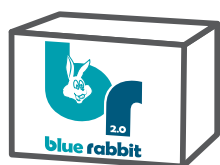





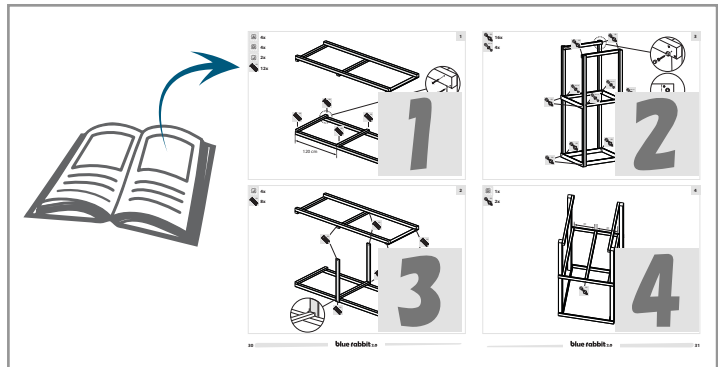
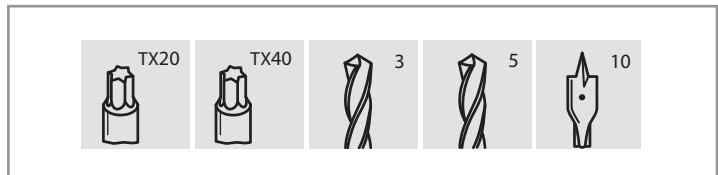
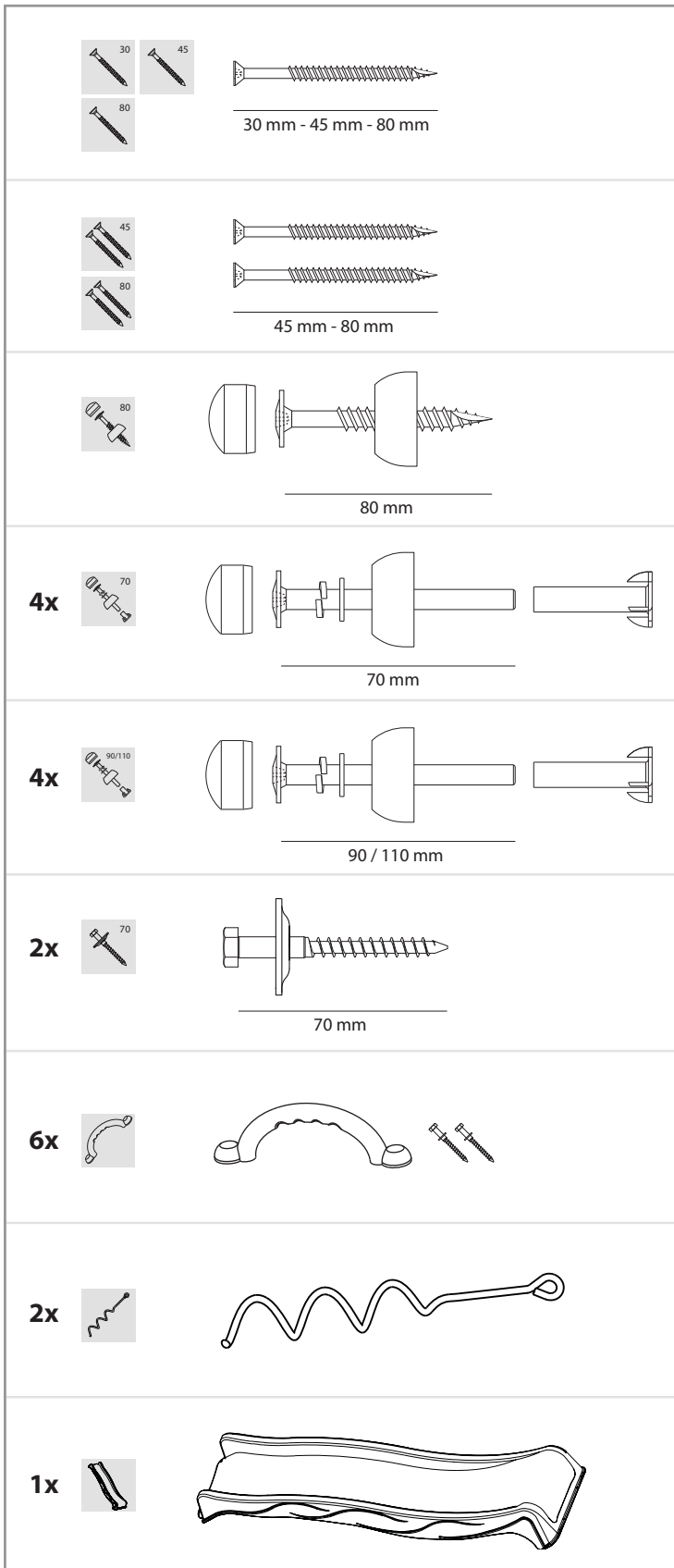



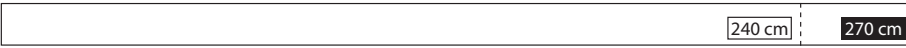



















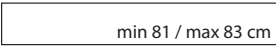



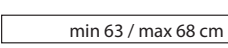

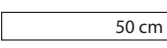

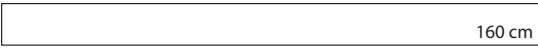
						@ramp 008.003.002.001		@challenger 008.003.007.001	
	@platform 008.003.006.001	@net 008.003.003.001	@bridge 008.003.004.001	@steps 008.003.008.001	@wall 008.003.001.001		@swing 008.003.005.001		
Pagoda 008.001.006.001									
	150 cm	X	⊖ ⊙	⊖ ⊙	⊖ ⊙	⊖ ⊙	X	⊖ ⊙	X
	120 cm	⊖ ⊙	X	⊖ ⊙	⊖ ⊙	X	⊖ ⊙	X	⊖ ⊙

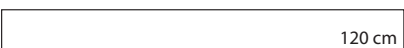

?
53 x 28 x 11 cm 6,3 kg

? x ?
78 120 x 80 x 158 cm 516 kg

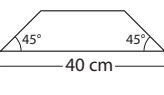

- 2x **A** min 68 mm | max 90 mm  
 - min 68 mm
 - max 90 mm
- 3x **B** min 68 mm | max 90 mm  
 - min 68 mm
 - max 90 mm
- 1x **C** min 68 mm | max 90 mm  
 - min 68 mm
 - max 90 mm
- 2x **D** min 68 mm | max 90 mm  
 - min 68 mm
 - max 90 mm
- 1x **E** min 68 mm | max 90 mm  
 - min 68 mm
 - max 90 mm
- 2x **F** min 68 mm | max 90 mm  
 - min 32 mm
 - max 50 mm
- 4x **G** min 68 mm | max 90 mm  
 - min 32 mm
 - max 50 mm
- 6x **H** min 68 mm | max 90 mm  
 - min 32 mm
 - max 50 mm
- 2x **I** min 68 mm | max 90 mm  
 - min 32 mm
 - max 50 mm
- 2x **J** min 68 mm | max 90 mm  
 - min 32 mm
 - max 50 mm
- 2x **K** min 68 mm | max 90 mm  
 - min 32 mm
 - max 50 mm
- 4x **L** min 68 mm | max 90 mm  
 - min 32 mm
 - max 50 mm
- 3x 4x **M** min 44 mm | max 45 mm  
 - min 44 mm
 - max 45 mm
- 3x 4x **N** min 44 mm | max 45 mm  
 - min 44 mm
 - max 45 mm
- 6x **O** min 95 mm | max 145 mm  
 - min 15 mm
 - max 22 mm
- 10x*/15x** **P** ** min 95 mm | * max 145 mm  
 - min 15 mm
 - max 22 mm
- 4x **Q** min 95 mm | max 145 mm  
 - min 15 mm
 - max 22 mm
- 16x*/24x** **R** ** min 95 mm | * max 145 mm  
 - min 15 mm
 - max 22 mm
- 15x*/20x** **S** ** min 95 mm | * max 145 mm  
 - min 15 mm
 - max 22 mm
- 2x **T** min 95 mm | max 145 mm  
 - min 15 mm
 - max 22 mm

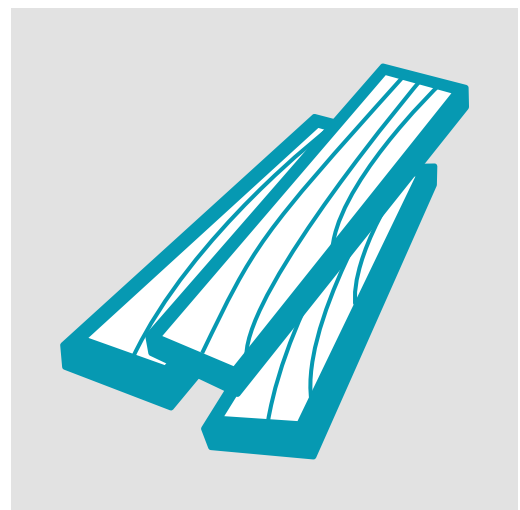
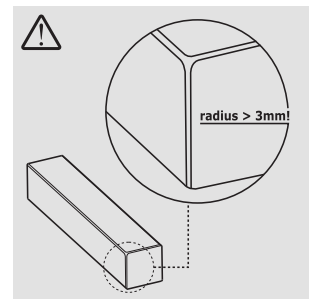
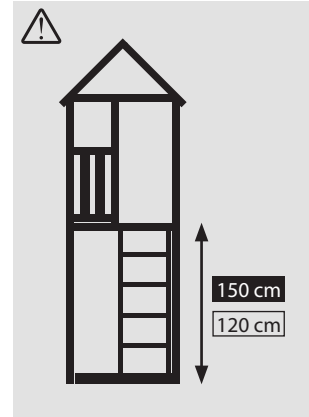



blue rabbit

Blue Rabbit 2.0®
Hemelrijken 8
B-2890 Sint-Amands
BELGIUM

info@bluerabbit.be

www.bluerabbit.be